

# SPECIFICATION KOZ CABLE CLAMP ST 26-38

<b>Application:</b>	Suitable for mounting single- and multiple-conductor low- medium- and high voltage cables.
<b>Range:</b>	For cables with a nominal outer diameter of 26 up to 38 mm.
<b>Material:</b>	Black polyamide (PA66), fibreglass-reinforced, virgin material.
<b>Fire resistance:</b>	UL94 V-0 and classification standard EN 45545-2: 2020 – Railway applications. Requirement set R22,R23 / Hazard level HL1,HL2.
<b>Standards:</b>	Certified in accordance with the international standard NEN-EN-IEC 61914:2016.
<b>Temperature:</b>	Permanent application from -80°C to +120°C. Short-term heating of up to +220°C.
<b>Advantages:</b>	Resistant to oils, greases, frost, heat, UV, ozone, salt water, salts, acids and aggressive chemicals. Non-oxidizing, non-corrosive, non-magnetic and non-conductive. Halogen-free and no sharp edges. Lifetime warranty, easy assembly and available worldwide.

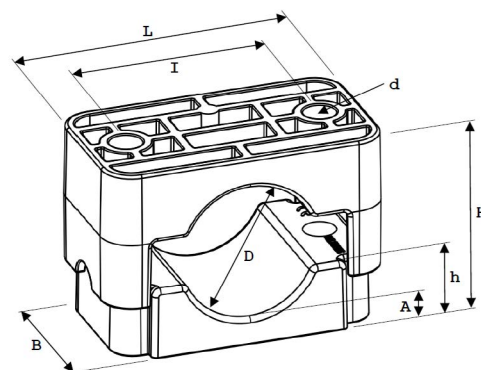

Initial torque for fastening fixing material : 5 – 8 Nm.  
(depends on cable manufacturer's prescription).

Tests have been performed by KEMA, SGS, KU Leuven, UL and Schneider.

The product listed in this datasheet is produced in conformity with the latest EU Directive 2011/65 / EU (RoHS), and complies with all legal obligations in accordance with REACH.

**DIMENSIONS IN MILLIMETERS**

Type	DØ	L	B	I	dØ	H	h	A	Strength (N)
<b>KOZ ST 26-38</b>	26-38	92	60	60	12,5	48-60	21	10	35.200