

## SPECIFICATIONS KOZ CABLE MOUNTING CLAMP TRI 3X 38-53

- Application** : suitable for fitting 3 single-conductor cables with high short-circuit load triangular arrays
- Range** : for cables with nominal outer diameters of 38 to 53 mm
- Material** : Polyamide, fiberglass-reinforced, black, resistance to UV rays, salt water, ozone, oils, fuels, alkalis and radioactive rays, halogen free, fully recyclable.
- Flame resistance** : UL94 V-0 and classification following DIN 5510-2:2009 with flammability class S3, smoke SR2 and dripping ST-2.
- Standards** : according to International Standard NEN-EN-IEC 61914:2009, Certificate of Conformity KOZ No 16881C by SGS.
- Flexure strength** : 210 N/mm<sup>2</sup>
- Tensile strength** : 120 N/mm<sup>2</sup>
- Thermal expansion** : 0,01% per 10° C temperature increase.
- Temperature limits** : Permanent application from -50° C to +120°. Brief heating up to 220°.
- Mechanical strength** : tested at KEMA up to 38.700 N.
- Fitting** : the central fastening hole in the bottom part of the KOZ TRI clamps means they can be fastened to e.g. masts and poles, as well as to concrete and fitting rails

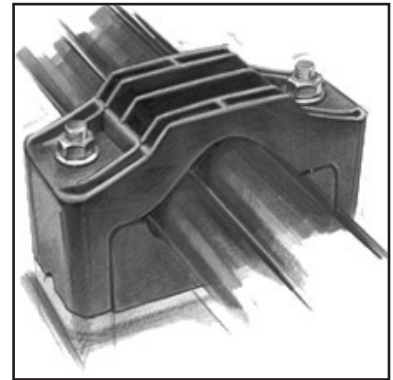

Initial torque for fastening bolts, nuts, screws : 5 – 8 Nm  
 (depends on cable manufacturer's prescription.)

All tests have been done by KEMA Netherlands, SGS Belgium, Underwriters Laboratories Inc. and Schneider France.

All products listed in this catalogue are fully compliant manufactured with the EU Directive 2002/95/EG (RoHS) and Annex 2005/618/EG and 2005/717/EG. Meeting all legal obligations under REACH.

Dimensions in millimetres

Type	DØ	L	B	I	dØ	H	h	A	Weight/Gram
KOZ TRI 3x38-53	38-53	190	80	145	14,5	80-115	54	30	890

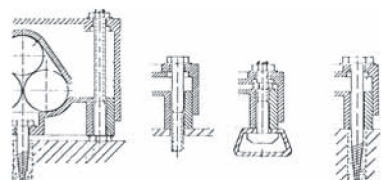

Fixing possibilities

No rights may be derived from the indicated sizes, as the products re subject to ongoing development. KOZ therefore reserves the right to implement these changes without notice. For the most up-to-date information, see our Internet site: [www.kozproducts.com](http://www.kozproducts.com)

