

SPECIFICATIONS KOZ CABLE CLAMP TYPE ST

- Application** : suitable for fitting single- and multiple-conductor low- medium and high voltage cables
- Range** : for cables with a nominal outer diameters from 18 up to 130 mm
- Material** : Polyamide, fiberglass-reinforced, black, resistance to UV rays, salt water, ozone, oils, fuels, alkalis and radioactive rays, halogen free, fully recyclable.
- Flame resistance** : UL94 V-0 and classification following DIN 5510-2:2009 with flammability class S3, smoke SR2 and dripping ST-2.
- Standards** : according to International Standard NEN-EN-IEC 61914:2009, Certificate of Conformity KOZ No 16881C by SGS.
- Flexure strength** : 210 N/mm²
- Tensile strength** : 120 N/mm²
- Thermal expansion** : 0,01% per 10° C temperature increase.
- Temperature limits** : Permanent application from -50° C to +120°. Brief heating up to 220°.
- Mechanical strength** : tested at KEMA from 20.000 N. up to 40.000 N.
- Initial torque for fastening bolts, nuts, screws** : 5 – 8 Nm (depends on cable manufacturer's prescription).

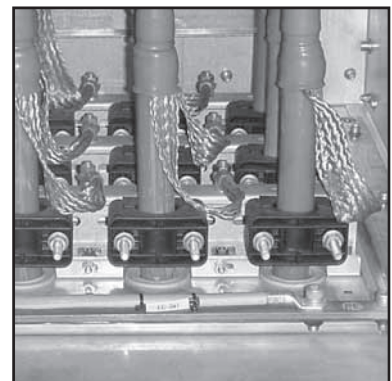
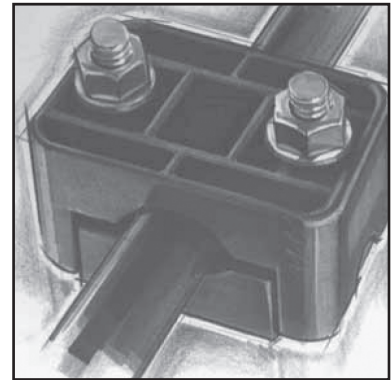

All tests have been done by KEMA Netherlands, SGS Belgium, Underwriters Laboratories Inc. and Schneider France.

All products listed in this catalogue are fully compliant manufactured with the EU Directive 2002/95/EG (RoHS) and Annex 2005/618/EG and 2005/717/EG. Meeting all legal obligations under REACH.

Dimensions in millimetres

Type	DØ	L	B	I	dØ	H	h	A	Weight/Gram
KOZ ST 18-26	18-26	77	45	49	10,5	36-44	13,5	6	90
KOZ ST 26-38	26-38	92	60	60	12,5	48-60	21	10	170
KOZ ST 36-52	36-52	108	60	75	12,5	58-74	27	11	225
KOZ ST 50-75	50-75	128	60	95	12,5	76-101	35	14	310
KOZ ST 75-100	75-100	169	80	127	14,5	110-135	51	19	815
KOZ ST 100-130	100-130	200	80	158	14,5	141-170	65	20	1000

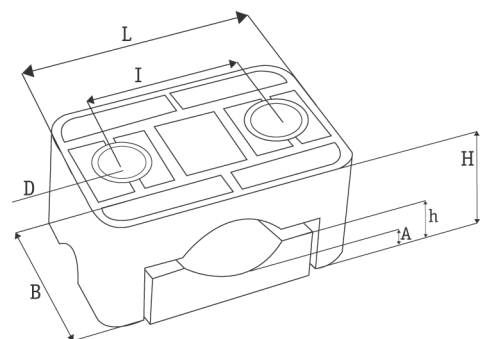

Fixing possibilities

No rights may be derived from the indicated sizes, as the products re subject to ongoing development. KOZ therefore reserves the right to implement these changes without notice. For the most up-to-date information, see our Internet site: www.kozproducts.com